

HSP

NOTES:

Current Rating: 1.0AMP
 Contact Resistance: 20mΩ Max
 Withstand Voltage: 500V AC/DC
 Insulation Resistance: 1000MΩ Min
 Operation Temperature: -40°C to +105°C

Contact Material: Phosphor Bronze
 Contact plating: Au Or Sn over Ni
 Insulator Material: PBT+30%G.F UL94V-0

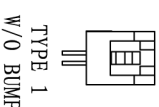
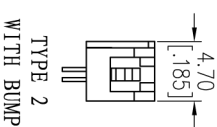
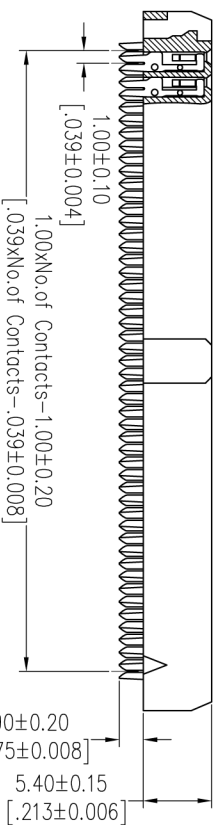
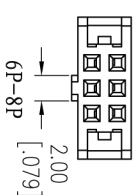
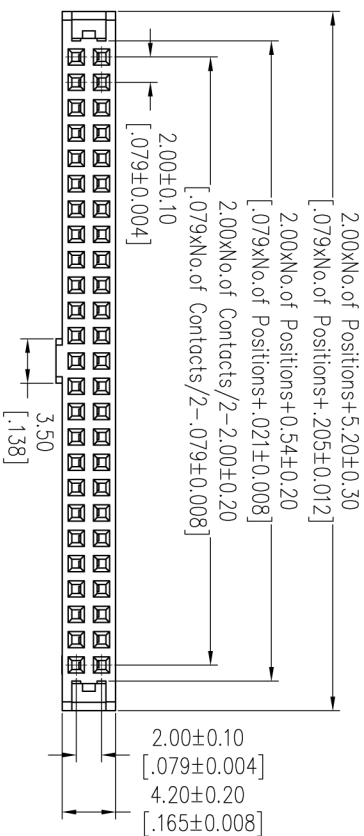
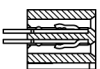

Ordering Information

5222-XX Y P XX B X 0 1

Two Parts No. of Pins Contact Plating Color Insulator Bump
 Comr-Cover 06P 26P S0=Gold Flash/Ni B=Black N=W/O Bump
 08P 30P S3=10u"Gold/Ni G=Grey(427C) W=With Bump
 10P 34P S4=15u"Gold/Ni
 12P 36P S5=30u"Gold/Ni
 14P 40P SN=Tin
 16P 44P
 18P 50P
 20P 60P
 22P 64P
 24P

Item	Pitch	Mating
Standard	2.00	3111/3220
Alternate		

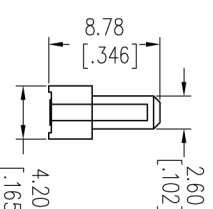
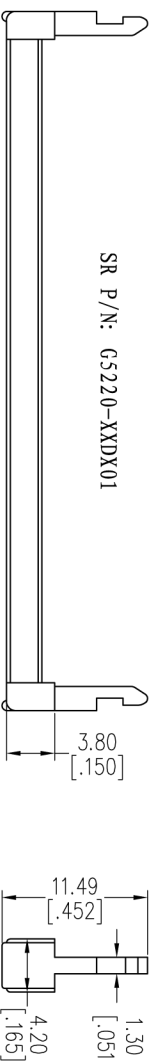

TYPE	PART NO.
TYPE 1	5222-XXYPXXBN01
TYPE 2	5222-XXYPXXBW01

SR P/N: G5220-XXDX01

OPERATION

XX ±0.40
 XXX ±0.25
 XXXX ±0.15

DRAW
 JYhuang

DATE
 2012/10/10

SCALE
 UNIT
 FIT
 mm
 A4

PART NO.
 SEE TABLE
 TITLE:
 2.00 IDC SOCKET+SR (ONE SIDE CONTACT)

hf 上海回峰电子科技有限公司
 Shanghai Hui Feng Electronic Technology Co., Ltd.

电话: 021-67150229
 传真: 021-67150251
 企业邮箱: hui Feng_dzki@163.com
 公司网站: www.huifeng-china.com

REV	DATE	MODIFICATION DESCRIPTION	CHANGE
A0	2012/10/10	NEW	-----

OPERATION
 DIM TOL

CHECK
 APPROVE

DATE

SHEET
 1/1

PART NO.
 SEE TABLE
 TITLE:
 2.00 IDC SOCKET+SR (ONE SIDE CONTACT)

hf 上海回峰电子科技有限公司
 Shanghai Hui Feng Electronic Technology Co., Ltd.

电话: 021-67150229
 传真: 021-67150251
 企业邮箱: hui Feng_dzki@163.com
 公司网站: www.huifeng-china.com